

RigExpert[®] Standard

User's manual

IMPORTANT:

*Read this manual carefully before
attempting to use
the RigExpert Standard device.*

Table of contents

Introduction	3
Description	4
Specifications	5
Front and rear panels	6
Setup instructions	7
RigExpert Standard structure diagram	7
Driver installation guide (Windows 2000/XP/2003/Vista)	8
Driver installation guide (Windows 98/ME)	9
Driver configuration guide (Windows 2000/XP/2003/Vista)	10
Driver configuration guide (Windows 98/ME)	11
Setting up software to operate using RigExpert Standard	12
Software setup example: MixW 2	13
Software setup example: DigiPan	14
Software setup example: MMTTY and DX4WIN	15
Software setup example: EchoLink	16
 Appendices	
A. Changing audio input or output gain, FSK baudrate and other jumper settings	17
B. 25-pin transceiver connector pinout	18
C. 25-pin transceiver connector description	19



RigExpert Standard

USB Transceiver Interface

RigExpert Standard is an electronic device designed to operate phone, CW, and digital modes using personal computer and transceiver. Previously, a TNC or sound card was needed for this purpose, along with lots of cables, occupying computer sound card and serial ports. All of this is not needed anymore. Following up-to-date technology, USB interface is chosen to connect RigExpert Standard to a computer. No additional interface circuit needed for transceiver connection.

RigExpert Standard combines:

- Transceiver audio interface for operating digital modes, voice recording and playback – a totally compatible sound card for any ham radio software.
- CAT (Computer Aided Transceiver) system, which controls transceiver frequency, mode and other functions by computer, supporting various models of transceivers.
- FSK operation to get crystal-clear RTTY signal.
- Serial (RS-232) port for connecting antenna rotors, TNCs or other serial devices.

Imagine a bulk of different black boxes with lamps and switches, a dozen of cables hanging down the table. This gloomy picture is well-known for a ham who prefers computer-assisted contesting or simply wants to check out digital modes. He spends a lot of money buying all this stuff, and then a lot of aspirin is needed to soften his headache while hooking it up to transceiver and computer and trying to start up the whole system...

We have done our best to make RigExpert Standard a breakthrough into the new era. Along with world-beater MixW software, it is a reconsideration of style a ham radio operator's workplace may be organized.

For a novice, it is a first ever chance to make sure operating digital modes is really easy. It lets experienced DX-men and contestmen enjoy the power of modern technology. Portable operators will appreciate its simplicity and reliability. At last, new horizons are open for experimenters.

RigExpert Standard is fully compatible with all existing radio amateur software, providing easy setup and use. Also, it includes squelch input for EchoLink software and even a separate DB-9 socket for TNC or antenna rotor.

RigExpert Standard features:

- Along with MixW software, operates phone, CW, PSK31, RTTY, Packet, AMTOR(FEC), MFSK, THROB, MT63, Hellschreiber, SSTV, receives PACTOR and fax images - all in one! No TNC required!
- Any other soundcard software may be used: tested with DigiPan, MMTTY, EchoLink, etc.
- Windows 98/ME/2000/XP/2003/Vista, as well as Mac OS and Linux compatible.
- Makes free computer soundcard and COM ports previously used for operating digital modes.
- USB connection to computer.
- Single 25-pin connector for transceiver connection.
- CAT interface tested with Icom, Kenwood, Yaesu, Ten-Tec, Elecraft and JRC transceivers. The device is able to work with any future type of transceiver.
- Transformer coupled audio input and output to minimize interference.
- Shielded metal case.
- Comprehensive documentation and support.

Internet links

www.mixw.net – MixW software

www.rigexpert.com - fresh news and updates regarding RigExpert Standard

RigExpert Standard is a device for operating phone, CW and digital modes using personal computer with USB port. It provides:

- Transceiver audio interface

Analog audio interface is a connection to transceiver audio output (external speaker connector or line output) and transceiver audio input (microphone connector or line input). Audio interface enables operating digital modes, recording and playing voice, as well as other useful functions (such as measuring levels of a signal from the air) by using a computer. Input (two channels) and output volume levels are adjusted by potentiometers on the front panel of the device.

- CAT interface for various transceiver models

CAT (Computer Aided Transceiver) system provides control of transceiver frequency, operating mode and other functions by computer software. Normally, modern transceivers have serial (with various signal levels) link providing CAT interface.

In RigExpert Standard, CAT interface port is seen as a COM port by computer software.

- FSK output

FSK (Frequency Shift Keying) is a popular method of transmitting digital messages over radio primarily used in radioteletype (RTTY) mode. Most transceivers provide FSK modulator feature to make the RTTY signal stable and clear.

A separate COM port is assigned for the FSK output when using RigExpert Standard. FSK baudrate and polarity are fixed and may be reconfigured by jumpers (see the Appendix A).

- PTT and CW output functions

Transceivers provide PTT (Push To Talk) and CW (Continuous Wave) keyer inputs to allow setting the transmitter on or off and operating CW using external device (PTT pedal, CW bug or paddle, terminal node controller, or personal computer).

In RigExpert Standard, PTT and CW outputs are assigned to the RTS and DTR lines of a separate COM port.

- Squelch input

Some software, such as EchoLink, requires the interface to provide a squelch input to detect if the radio channel is busy.

In RigExpert Standard, the squelch input is assigned to the DCD line of the COM port used for PTT and CW outputs.

- Additional serial port

Connecting TNCs or antenna rotors still require legacy COM ports which are unavailable on modern PCs. Having a 9-pin SERIAL connector (TXD/RXD/RTS/CTS lines) will resolve this problem.

In RigExpert Standard, a separate COM port is assigned to the SERIAL input/output.

General features

- Transceiver audio interface for operating digital modes, voice recording and playback
- CAT (Computer Aided Transceiver) system
- FSK output
- Additional SERIAL input/output

Computer connection

- USB (Universal Serial Bus) connector
- Powered from the USB port (consuming 100 mA maximum)
- No external power supply needed

Transceiver connection

- Single 25-pin connector for transceiver cable
- Various transceiver models supported

Audio interface

- Insulated from digital nets
- Maximum input/output amplitude is 1V
- Input/output samplerate: 8 to 48 kHz
- True 16-bit DAC/ADC used
- Volume levels are adjusted by the front panel potentiometers and on-board jumpers

CAT serial port

- Baudrate: 300-115200 baud
- Electrical compatibility: RS-232, CI-V, TTL or inverted-TTL (Yaesu, Icom, Kenwood, Ten-Tec, Elecraft and JRC transceivers)

PTT/CW outputs

- PTT output: open collector and TTL-level
- CW output: open collector
- Maximum current is 50 mA

FSK output

- Open collector output
- Baudrate is adjusted by the on-board jumpers (preset to 45.45 baud).

SERIAL input/output

- Baudrate: 300-115200 baud
- Electrical compatibility: RS-232 (TXD/RXD/RTS/CTS lines)

System requirements

- Desktop or laptop computer with USB 1.1 or USB 2.0 compliant port
- Windows 98/ME/2000/XP/2003/Vista or Mac OS or Linux operating system

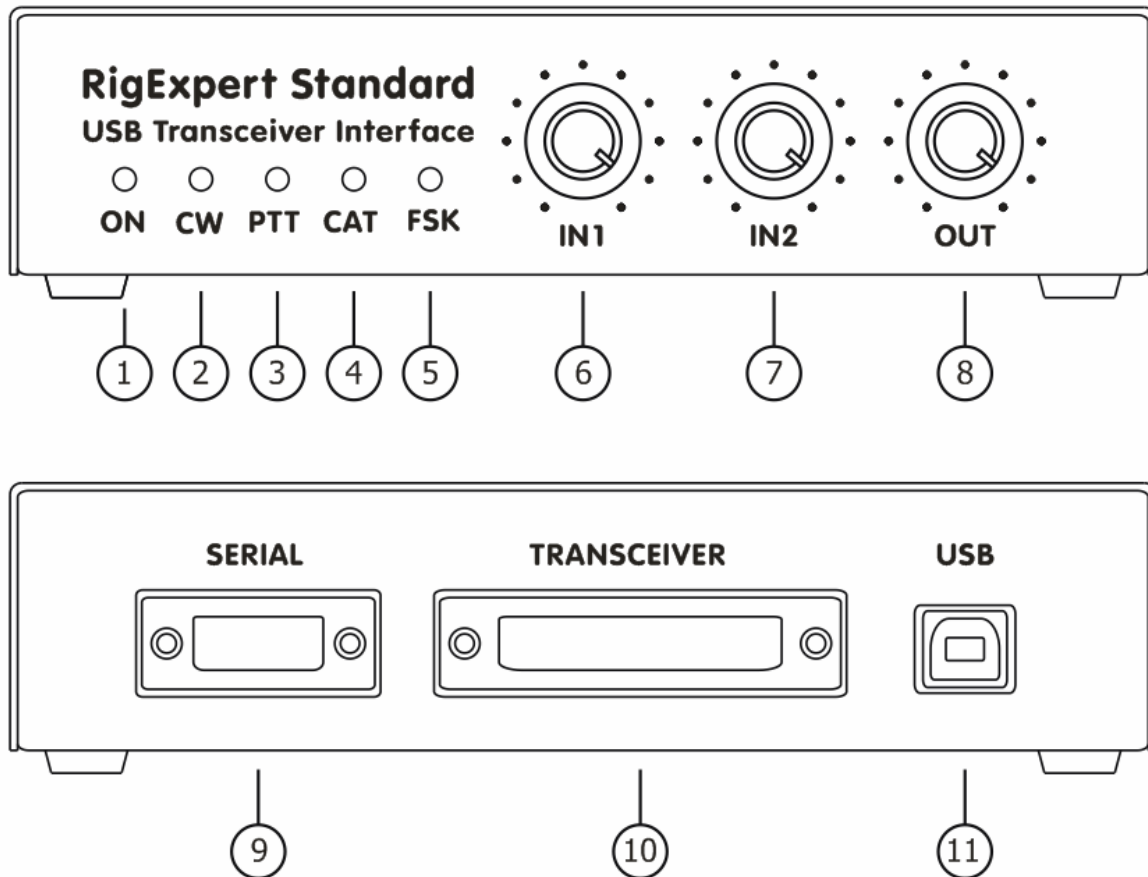

1. **ON.** Lights when the RigExpert Standard device is plugged in and the drivers are installed.
2. **CW.** Shows transmissions in CW mode.
3. **PTT.** Indicates when the transceiver transmits.
4. **CAT.** Monitors CAT data exchange between transceiver and computer.
5. **FSK.** Lights when RigExpert Standard is sending FSK data.
6. **IN1.** Input level, channel 1 (main receiver audio).
7. **IN2.** Input level, channel 2 (sub-receiver audio).
8. **OUT.** Output level (audio to the transceiver).

9. **SERIAL** - 9-pin serial port connector.
10. **TRANSCEIVER.** 25-pin transceiver connector.
11. **USB.** Connect to the computer USB port.

There are several steps needed to get ready to operate using RigExpert Standard device:

- 1) Insure the RigExpert Standard is *unplugged* from both computer and transceiver.
- 2) Windows users: Insert the RigExpert Standard CD into your CD-ROM drive. If the CD does not auto-start, run **SetupRES** from the CD. All necessary software will be copied on your hard drive. Windows 98/ME, as well as Mac OS and Linux users will have to install the drivers manually from the *Drivers* folder on the supplied CD.
- 3) Plug the RigExpert Standard device into the computer's USB port using supplied USB cable.
- 4) Windows 98/Me users: When the *Found New Hardware Wizard* appears asking for drivers, click *Browse* and select `\Drivers\Win98ME` on the CD as a driver files location. See the following Driver Installation Guides for details, if needed. Repeat this step until all components of RigExpert Standard are installed.
- 5) Set up the serial port numbers and parameters, according to the Driver Configuration Guides, if needed.
- 6) Connect RigExpert Standard to your transceiver using the supplied transceiver cable. Please *turn off* your transceiver while doing this. Perform this step carefully, since incorrect cable connection *may harm* the RigExpert Standard device or your transceiver.
- 7) Set up MixW2, DigiPan or other soundcard software (see the following examples).
- 8) For additional info and troubleshooting, see the RigExpert Standard website: www.rigexpert.ua.

RigExpert Standard structure diagram

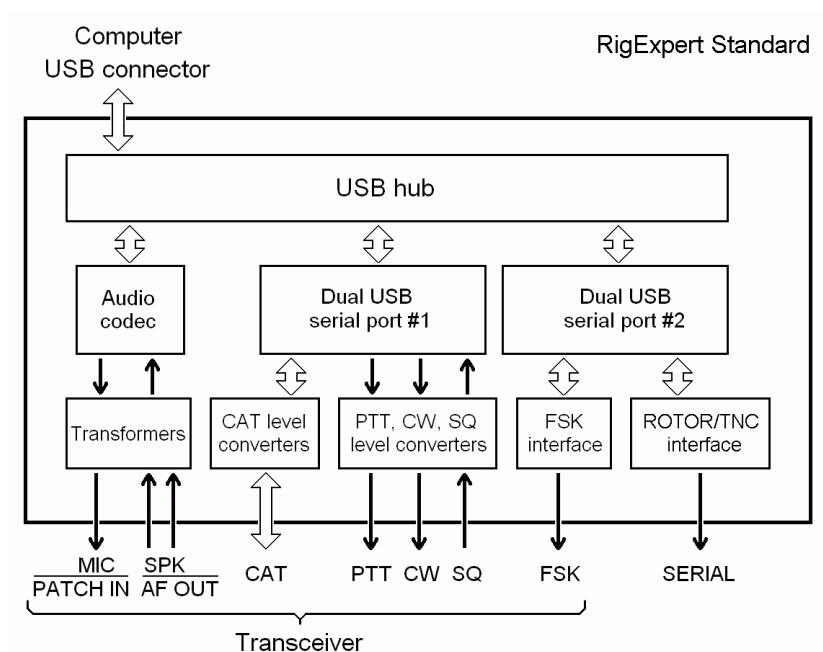

Normally, the Microsoft Certified driver for these operating systems is installed when you first run the RigExpert Standard CD. Additionally, you may find the driver files in the ***Drivers*** folder on the CD.

Continue with driver settings when you see "***Your hardware is installed and ready to use***" message.

1. After the RigExpert Standard device is plugged into the computer USB port, a **Found New** window will pop up on the computer screen.

2. A few seconds later, the **Add New Hardware Wizard** will start. Click **Next** to continue.



3. In the next window, select **Search for the best driver for your device** and click **Next**.



4. Check **Specify a location** and click **Browse** to browse for the drivers directory (normally, this is `\Drivers\Win98ME` folder on your CD), then click **Next** to continue.



5. Click **Next** when you see the **"Windows is now ready to install..."** window.



6. In the **"Windows has finished installing..."** window, click **Finish**.



7. Please repeat steps 2-6 when Windows finds RigExpert Standard subdevices.

8. Now the drivers are installed and are ready to be configured (see page 11).

This guide describes Windows XP case. Other Windows versions are similar.

1. As a result of successful installation, you will see four new serial ports in the **Device Manager** (right-click **My Computer** on the desktop, select **Manage** from the menu, select **Device Manager** from the list on the left side of the window, then open **Ports (COM&LPT)** branch on the right).

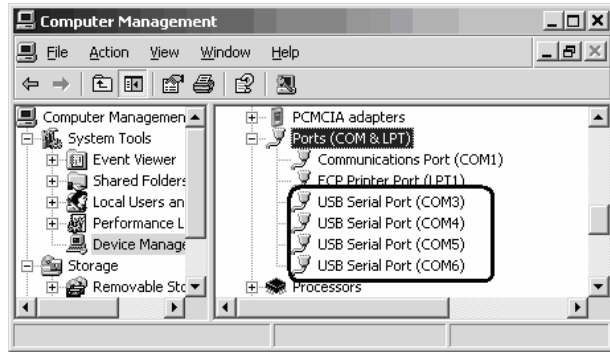

2. To view the RigExpert Standard serial port assignment, please run the **ListRE** program from **Start – Programs – RigExpert Standard – Show serial ports**:

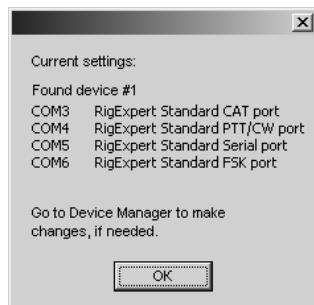

3. Write down the port numbers on a piece of paper. For instance,

CAT port: COM3
PTT/CW port: COM4
SERIAL port: COM5
FSK port: COM6

These port numbers will be needed later to set up your software.

4. Changing serial port numbers.

The serial port numbers are assigned automatically during driver installation. If you need to change their values, open **Device Manager**, right-click the **USB Serial Port (COMxx)**, then select **Properties** from the menu. In the **USB Serial Port (COMxx) Properties** dialog, activate **Port Settings** tab, then click **Advanced** button.

In the newly-open **Advanced Settings for COMx** dialog, select a new **COM Port Number**.

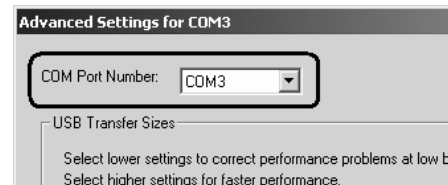

Click **OK** to apply new settings and close the **Advanced Settings for COMx** dialog.

You will have to re-plug the RigExpert Standard device for this change to take effect.

It is recommended for all four ports to uncheck the **Serial Enumerator** check-box in the same window:

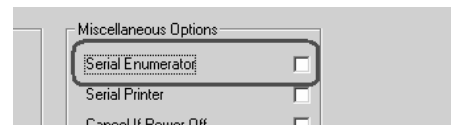

This will eliminate a case when Windows is trying to find a mouse or other device on this port when you plug in the RigExpert Standard.

1. As a result of successful installation, you will see four new serial ports in the **Device Manager** (right-click **My Computer** on the desktop, select **Properties** from the menu, then select **Device Manager** tab in the **System Properties** dialog. Open **Ports (COM & LPT)** branch in the device tree.)

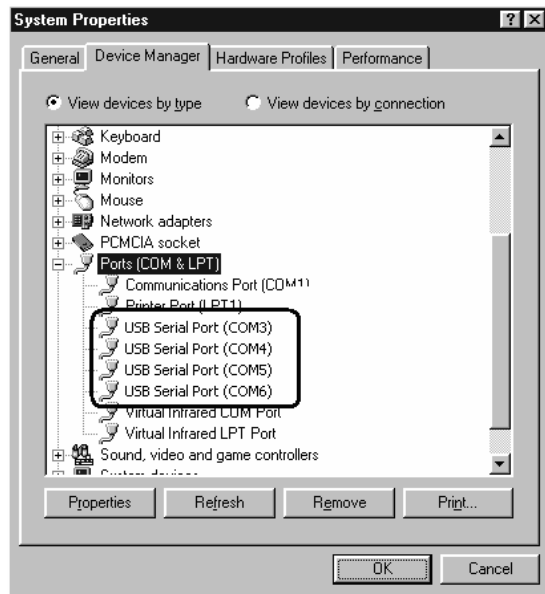

2. To view the RigExpert Standard serial port assignment, please run the **ListRE** program from **Start – Programs – RigExpert Standard – Show serial ports**:



3. Write down the port numbers on a piece of paper. For instance,

CAT port: COM3
PTT/CW port: COM4
SERIAL port: COM5
FSK port: COM6

These port numbers will be needed later to set up your software.

4. Changing serial port numbers.

The serial port numbers are assigned automatically during driver installation. If you need to change their values, open **Device Manager**, right-click the **USB Serial Port (COMxx)**, then select **Properties** from the menu. In the **USB Serial Port (COMxx) Properties** dialog, activate **Port Settings** tab, then click **Advanced** button.

In the newly-open **Advanced Port Settings** dialog, select a new **COM Port Number**.

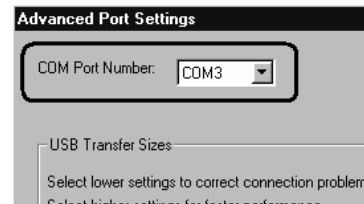

Click **OK** to apply new settings and close the **Advanced Port Settings** dialog.

You will have to re-plug the RigExpert Standard device for this change to take effect.

It is recommended for all four ports to uncheck the **Serial Enumerator** check-box in the same window:

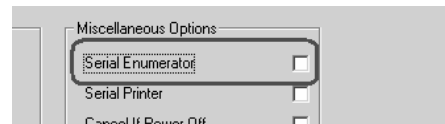

This will eliminate a case when Windows is trying to find a mouse or other device on this port when you plug in the RigExpert Standard.

Setting up software to operate using RigExpert Standard 12

There are few settings that have to be done (or verified) in the software once the RigExpert Standard device is plugged in and the drivers are installed. A combination of two or more programs may be set up to use all functions of RigExpert Standard. Please see the software setup examples on the following pages.

CAT system

- In the software, select the *CAT port*.
- Set up baudrate, stop bits and parity parameters according to your transceiver manual.
- RTS and DTR behavior is not significant, since RigExpert Standard does not use these lines at CAT port.

PTT and CW outputs

- In the software, select the *PTT/CW port*.
- Set RST line to match the PTT output.
- Set DTR line to match the CW output.
- Baudrate, parity and other port settings are not significant.

FSK output

- In the software, select the *FSK port*.
- The FSK baudrate is fixed at 45.45 baud (which is a standard for amateur radio). To change the baudrate, see Appendix A.

SERIAL port

- In the software, select the *SERIAL port*.
- Please make sure the software handles RTS/CTS and ignores DTR/DSR lines of the serial port.

Audio in/out

- In the sound card software, select the **USB Audio CODEC** sound card. Some programs can only work with so-called preferred sound card, which is selected via Control Panel, so there is no such a selection there. Other programs accept numerical device IDs, so please refer to corresponding help files.
- Adjust input and output volume using front panel potentiometers. This procedure is well-described in various documents and publications, and is better done when the whole system is set up.

Important:

Please remember that since CAT and PTT/CW lines are located on *two different* COM ports, software *should* also be set to use separate ports for CAT and PTT/CW outputs.

Also, please make sure the transceiver is set up properly. For Icom transceivers, check the CI-V address to correspond the software setting. Switch Yaesu transceivers in PKT mode if your RigExpert Standard is plugged into the transceiver PACKET connector.

Additionally, please insure that the CW input in your transceiver is configured to use straight key.

1. Run MixW 2 and open the *Sound Device Settings* dialog from *Configure* menu. Choose *Computer soundcard* as a device type, then select *USB Audio CODEC* as input and output devices. Perform other sound device settings, if needed.

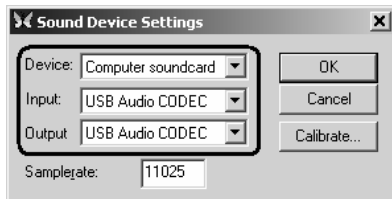

2a. Go to *Configure – TRCVR CAT/PTT* menu to open the *PTT & CAT* dialog.

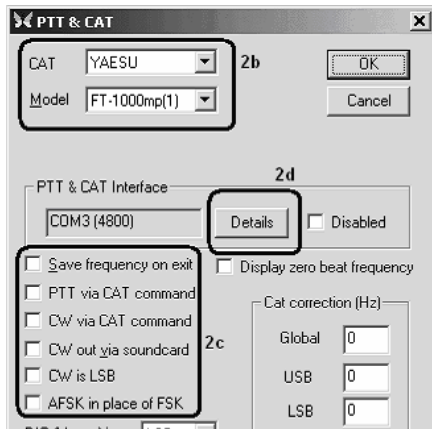

2b. Select your transceiver type and model (see the *PTT&CAT* dialog above).

2c. Perform additional settings according to MixW2 manual.

- To use CW output from RigExpert Standard, uncheck the *CW out via soundcard* check-box.
- For using FSK mode with RigExpert Standard, uncheck the *AFSK in place of FSK* check-box.

2d. Click *Details* to configure the CAT serial port.

3. In the *Serial Port* dialog, select your *CAT port* number as a *Port*, then set the serial port parameters according to the transceiver manual. RTS and DTR settings have no effect with RigExpert Standard.

3. (continued)

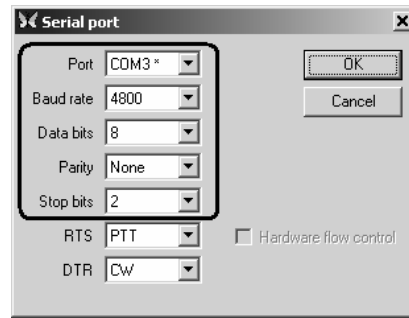

4. Go to *Configure – Secondary PTT port – Port settings* menu. In the *Serial Port* dialog, select the *PTT/CW port* number as a *Port*, then set *RTS* to PTT, and *DTR* to CW. Uncheck *Hardware flow control*. Other settings have no effect with RigExpert Standard.

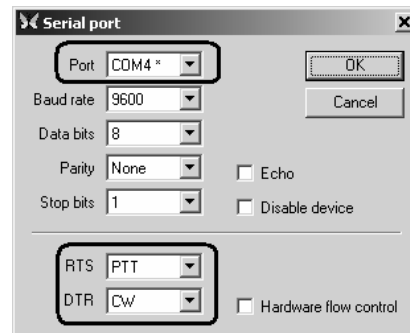

5. Go to *Configure – FSK port – Port settings* menu. In the *Serial Port* dialog, select the *FSK port* number as a *Port*. RTS and DTR settings have no effect with RigExpert Standard.

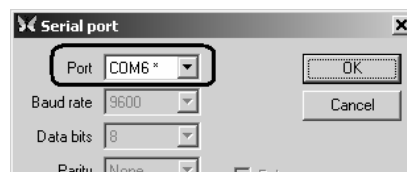

6. Go to *Configure – Rotor – Settings* menu. In the *Serial Port* dialog, select the *SERIAL port* number as a *Port*. Select other parameters, such as *Baud rate* to be able to connect an antenna rotor to the *SERIAL port* of RigExpert Standard device.

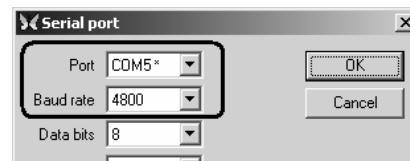

1. Run DigiPan and open the *Sound Card* dialog from *Configure* menu.

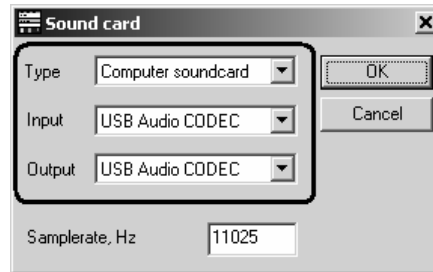

Choose *Computer soundcard* as a sound card type, then select *USB Audio CODEC* as input and output.

2. Go to *Configure – Serial port* menu to open the *PTT interface* dialog.

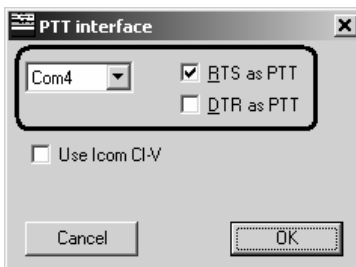

Select your **PTT/CW port** here, then check *RTS as PTT* check-box.

1. Perform audio in/out settings

1a. In MMTTY, go to **Options** – **Setup MMTTY** menu.

1b. In the **Setup MMTTY** dialog, select the **Misc** tab.

1c. Select **Device ID** to match the RigExpert Standard sound card (usually, **0** or **1**).

1d. Select **COM-TxD (FSK)** as a **Tx Port**. This setting will let MMTTY transmit RTTY via the FSK port.

*If you prefer the soundcard mode to be used instead of FSK, select **Sound** in the **Tx Port** area.*

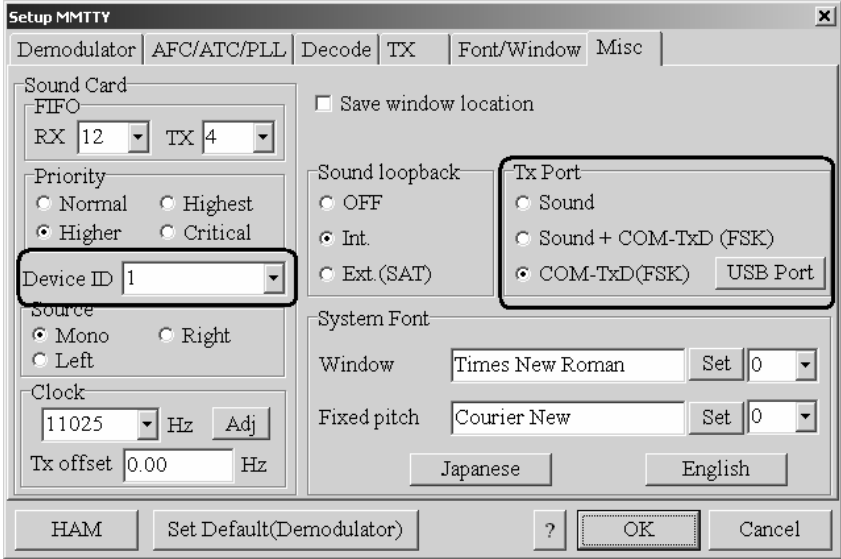

2. Set up FSK port number

2a. In the **Setup MMTTY** dialog, select the **TX** tab.

2b. Choose the Port in the **PTT** area to match the RigExpert Standard **FSK Port** (see the driver configuration guide).

*If using the soundcard mode (i.e. not FSK), select **PTT/CW port** of RigExpert Standard in the **PTT** area.*

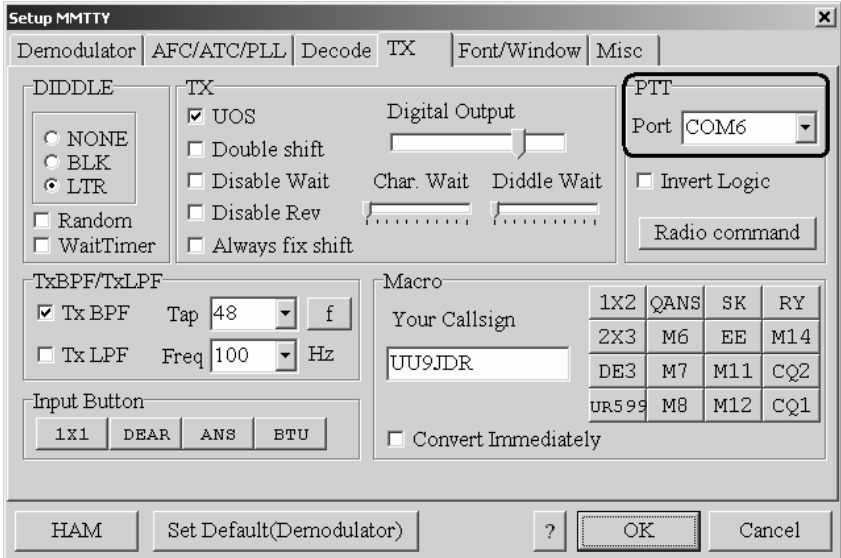

3. Set up CAT system

3a. In the DX4WIN software, go to **File** – **Preferences** menu.

3b. In the **Setup Parameters** dialog, open the **Radio** tab.

3c. Select your transceiver **Type** and parameters according to the transceiver manual.

3d. Select **COM Port** to match the RigExpert Standard **CAT Port** (see the driver configuration guide).

3e. Perform other settings according to the DX4WIN manual, if needed.

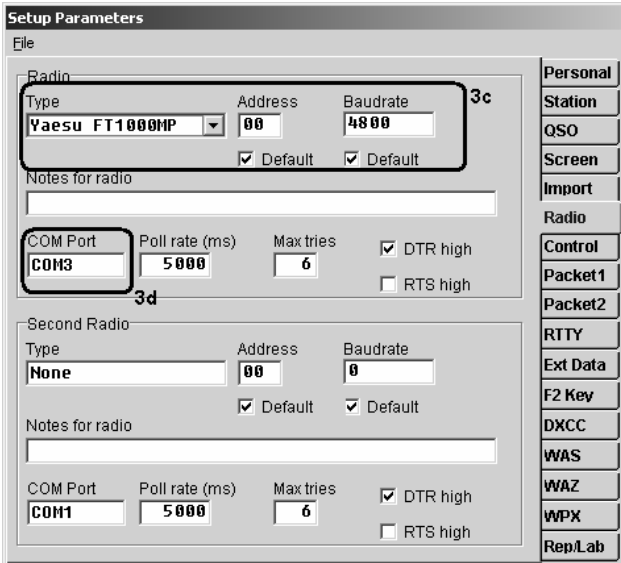

This example describes the use of RigExpert Standard in *Sysop* mode. Please see the EchoLink manual for additional information.

Please notice that RigExpert Standard cable diagrams do not show the connection between the transceiver's squelch output and pin 5 of the 25-pin connector on the back of RigExpert Standard. You will need to add this connection if you want to use the transceiver's squelch in EchoLink.

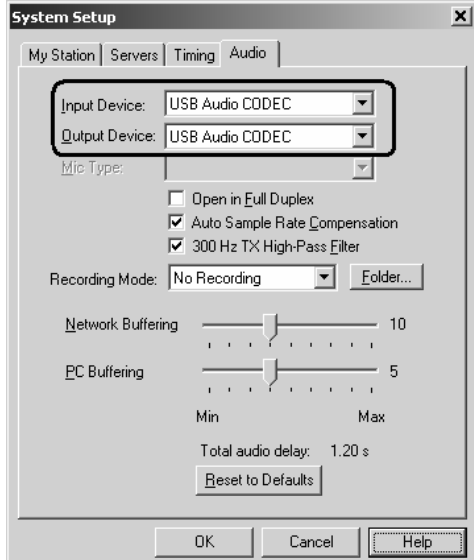
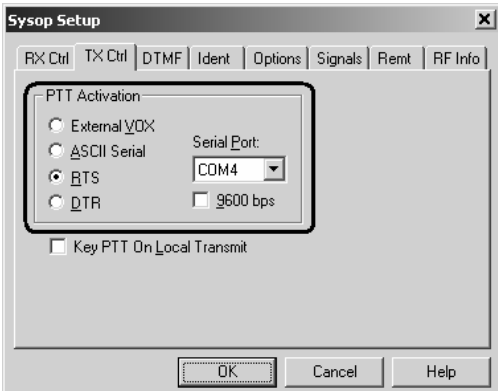
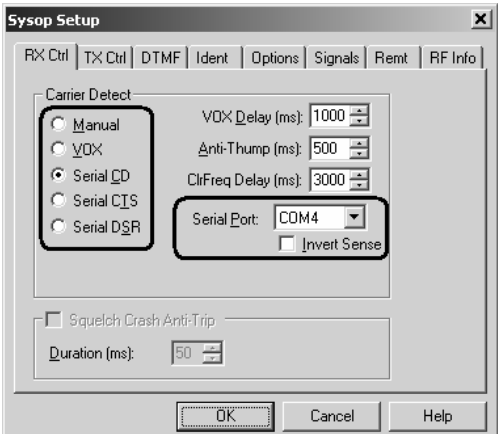
<p>1. Open Audio tab in the System Setup dialog.</p> <p>Choose USB audio CODEC as input and output devices.</p>	
<p>2. Open <i>Sysop Setup</i> dialog and select the TX Ctrl tab.</p> <p>Select RTS in the PTT Activation area, then select the Serial Port number to match the RigExpert Standard PTT/CW port (see the driver configuration guide).</p>	
<p>3. Select the RX Ctrl tab. To use a hardware carrier detect (squelch) feature, select Serial CD in the Carrier Detect area, then select Serial Port to match the RigExpert Standard PTT/CW port (see the driver configuration guide). You may need to check the Invert Sense check-box for some transceivers.</p> <p>However, in some cases it is better to check the VOX check-box not to use the transceiver's squelch.</p>	

Changing audio input or output gain, FSK baudrate and other jumper settings

In some cases, it is necessary to change audio input or output gain to satisfy transceiver requirements, or perform other additional settings.

Open the RigExpert Standard box with a screwdriver. Find a corresponding jumper and set it to a new position according to the following picture.

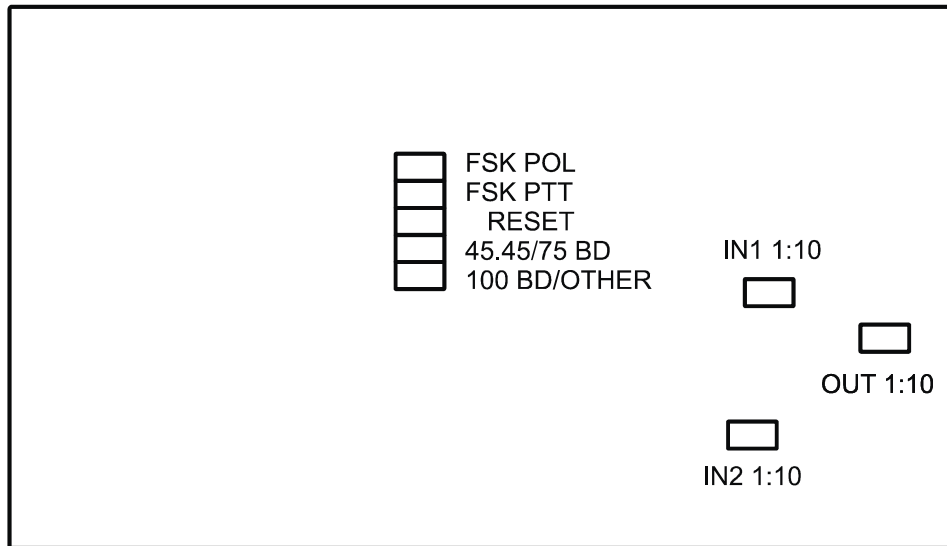

RigExpert Standard board

1. **FSK POL.** Open/close this jumper to change the output FSK signal polarity.
2. **FSK PTT.** Close this jumper if you want the transceiver PTT line be activated by transmitting FSK.
3. **RESET.** Not used.
4. **45.45BD/75BD.** Open this jumper to set the FSK baudrate to 75 baud. Close this jumper to set the baudrate to 45.45 baud.
5. **100BD/OTHER.** Close this jumper to set the FSK baudrate to 100 baud. Open this jumper for other baudrate.
6. **IN1 1:10.** Channel 1 (main receiver) attenuator (1:10).
7. **IN2 1:10.** Channel 2 (sub receiver) attenuator (1:10).
8. **OUT 1:10.** Transmitter attenuator (1:10).

Factory defaults:

- FSK PTT is ON
- Receiver and transmitter attenuators are ON
- FSK baudrate is set to 45.45 baud

Appendix B

25-pin transceiver connector pinout

Pin	Pin name	Description
1	FSK_OC	FSK open-collector output
14	FSK_PULLUP	Pullup to +5V through 4.7K resistor
2	-	Not used
15	-	Not used
3	VCC	+5V output (USB power line)
16	PTT5V	TTL-level PTT output (5V in transmit, 0V in receive mode)
4	CW_OC	Open-collector CW output
17	PTT_OC	Open-collector PTT output
5	SQ	Squelch input, 4.7K resistor pullup to +5V
18	12V_MAX	+12V output (generated by MAX232 chip)
6	SPK_TRCVR2	Transceiver audio output (speaker), sub receiver
19	RXD_OE	Serial input (5V levels), connect RXD5V to VCC to activate this input
7	CIV_IN	CI-V input (ICOM transceivers), pulled up to 12V_TRCVR with 4.7K resistor
20	12V_TRCVR	Connect to VCC to power the CIV_IN input
8	CIV_OUT	CI-V open-collector output (ICOM transceivers), connect to CIV_IN
21	CO_PULLUP	Pullup to +5V through 4.7K resistor
9	TXD12V	RS-232-compatible serial output ($\pm 12V$ levels)
22	RXD12V	RS-232-compatible serial input ($\pm 12V$ levels)
10	TXD5V	Serial output (5V levels)
23	RXD5V	Serial input (5V levels)
11	GND	Digital ground
24	GND	Digital ground
12	SPK_TRCVR	Transceiver audio output (speaker), main receiver
25	MIC_TRCVR	Transceiver audio input (microphone)
13	AGND_TRCVR	Audio signal ground

For transceiver cable design guide and cable diagrams for most popular transceivers, please see the www.rigexpert.ua website.

Appendix C

25-pin transceiver connector description

Audio in/out:

- SPK_TRCVR and SPK_TRCVR2 are connected to the transceiver speaker (or line out) output (main or sub receiver).
- MIC_TRCVR is connected to the transceiver microphone (or line in) input.
- AGND_TRCVR is connected to the transceiver ground (connection point should be as close to the transceiver as possible).

RigExpert Standard decouples audio in/out signals from computer signals using transformers, which prevents interference caused by parasitic current in grounding.

FSK output:

FSK_OC is an open-collector output, sinking 50mA maximum (using BC817 NPN transistor). Connect this pin to FSK_PULLUP to obtain the TTL-level output.

PTT and CW outputs:

PTT_OC and CW_OC are open-collector outputs, sinking 50mA maximum (using BC817 NPN transistors). PTT5V is a TTL-level PTT output (5V in transmit, 0V in receive mode), output current is 5mA maximum.

CAT serial in/out:

RigExpert Standard provides various methods of connecting serial in/out lines with different signal levels to the virtually any model of transceiver. This only requires shortening some pins on the RigExpert Standard transceiver connector.

- RS-232-compatible mode uses TXD12V and RXD12V lines with $\pm 12V$ signal levels, provided by MAX232 interface chip.
- CI-V mode uses CIV_IN and CIV_OUT lines (should be shortened together). CIV_IN is internally pulled up with 4.7K resistor to 12V_TRCVR, which should be connected to VCC.
- TTL-level (5V) mode uses TXD5V and RXD5V lines. Signal polarity is opposite to RS-232 mode.
- Yet another TTL-level mode (signal polarity is the same as with RS-232 mode) uses CIV_OUT output (should be connected to CO_PULLUP) and CIV_IN input (12V_TRCVR line should be connected to the VCC output). It is better to use RXD_OE input in this mode (RXD5V should be connected to VCC to activate this input).

Copyright © 2007 Rig Expert Ukraine Ltd.

RigExpert is a registered trademark of Rig Expert Ukraine Ltd.